

Article number: 12704000020800

Description: KLEE-coil 704 000 020.800
M2 Brass

Measures

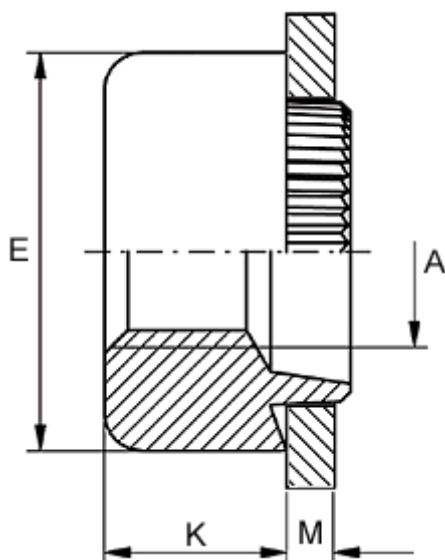

Female thread A	= M2
Height K	= 3.0
Outer diameter E	= 8.0
Plate thickness	= 0.9 to 1.0
Recommended bore diameter for extreme load	= 6.0
Recommended bore diameter for normal use	= 6.0